

2kW Smart Glass Panel Heater



IG952|WIFI / IG952|BLWIFI

Please read these instructions carefully before use and retain for future reference

**Before switching on your appliance,
always check for any damage which may have been caused in transit**

CONTENTS

Important Safety Instructions.....	3-5
Specifications.....	6
Appliance Overview.....	7-8
Assembly Instructions.....	8-10
Operating Instructions.....	11-13
Setting up Wi-Fi Function.....	14-21
Cleaning and Maintenance.....	22
Troubleshooting Guide.....	23
Fuse Replacement.....	24
Disposal Information.....	24
Igenix Warranty Terms and Conditions.....	26-27

IMPORTANT SAFETY INSTRUCTIONS

Read and follow all of the instructions even if you feel you are familiar with the product, and find a place to keep this manual handy for future reference.

- The appliance should not be used if it has been dropped or if there are visible signs of damage
- This appliance should only be used by adults
- Cleaning and user maintenance shall not be made by children
- Keep the appliance and its cord out of reach of children
- Children shall not play with the appliance
- Children should be supervised to ensure that they do not play with the appliance
- This appliance cannot be used by persons with reduced physical, sensory or mental capabilities
- This product is intended for domestic use only
- Do not use the appliance for anything other than the intended purpose
- This product is for indoor use only. Do not use the heater outdoors
- Ensure that the electricity supply in your home is rated at 220-240 volts before operating the appliance
- If the mains lead of this appliance becomes damaged, it must be replaced by a qualified electrician using the same rated cable in order to avoid a hazard
- Always turn off and unplug the appliance before attempting to move and when not in use
- Do not use the heater unless the feet are attached correctly or it is mounted on the wall
- Do not use the heater in the immediate surroundings of a bath, shower or swimming pool
- Do not reach for an appliance that has fallen into water. Switch off at power supply and unplug immediately

- Never place the heater where it may fall into water, or stand on a damp floor
- The appliance is not intended for use in bathrooms, laundry areas, near swimming pools or similar wet indoor locations
- Do not cover or obstruct any of the heat outlet grilles
- Do not place the heater on carpets with a deep pile
- Always ensure that the heater is placed on a firm, flat surface
- Always operate upright
- Never leave the appliance unattended whilst in use
- This appliance heats up when in use. To avoid burns, do not let bare skin touch the hot surface. Switch off and let the appliance cool before moving or touching
- Ensure that the heater is not positioned close to curtains or furniture as this may create a fire hazard. Place at least 50cm away from furniture and other objects
- Do not place the heater in front of, or immediately below a wall socket
- Do not insert any objects through the heat outlet grilles
- Do not use the heater in areas where flammable liquids are stored or flammable fumes may be present
- To protect against fire, electric shock or injury do not immerse the heater, power cord or plug in water or any other liquid
- Do not twist, kink or wrap the cord around the appliance, this may cause the insulation to weaken and split
- Do not run the cord under carpeting, rugs or runners. Arrange cord away from traffic so that it will not be tripped over
- The use of an extension cord with this appliance is not recommended
- Do not operate with the cord coiled as a build up of heat could be sufficient to become a hazard
- Do not place the appliance close to a radiant heat source
- Do not store the appliance while it is still hot
- Do not remove the plug from the power socket by pulling the

power cord. Always grip the plug

- Do not remove the plug from the socket until the appliance is switched off
- Do not use the appliance to dry clothes
- Do not operate the appliance with wet hands
- The most common cause of overheating is deposits of dust or fluff in the appliance. Ensure these deposits are removed regularly by unplugging the appliance and vacuum cleaning the grilles
- Use this appliance only as described in the manual. Any other use is not recommended by the manufacturer and may cause fire, electric shock or injury
- Do not use this heater with any external programmer, timer or any other device that switches the heater on automatically
- There are no user serviceable parts inside and the casing should not be opened by anyone other than a qualified electrician



This symbol means do not cover, in order to avoid overheating. Do not cover or obstruct any of the heat outlet grilles or air intake openings of the heater.



WARNING: In order to avoid overheating, do not cover the heater

SPECIFICATION

Product	Wi-Fi Glass Panel Heater
Model Number	IG9521WIFI / IG9521BLWIFI
Brand	Igenix
Colour	White / Black
Wattage (W)	2000
Voltage (V)	220-240V
Frequency (Hz)	50-60
Product Dimensions (mm)	H 430 x W 815 x D 66
Net Weight (kg)	7.1
Class	I
Overheat Protection	Yes

APPLIANCE OVERVIEW

1. Control box cover plate
2. Control panel and digital display
3. Glass front cover
4. Feet
5. Rear cover
6. Wall hanging rack
7. Control box

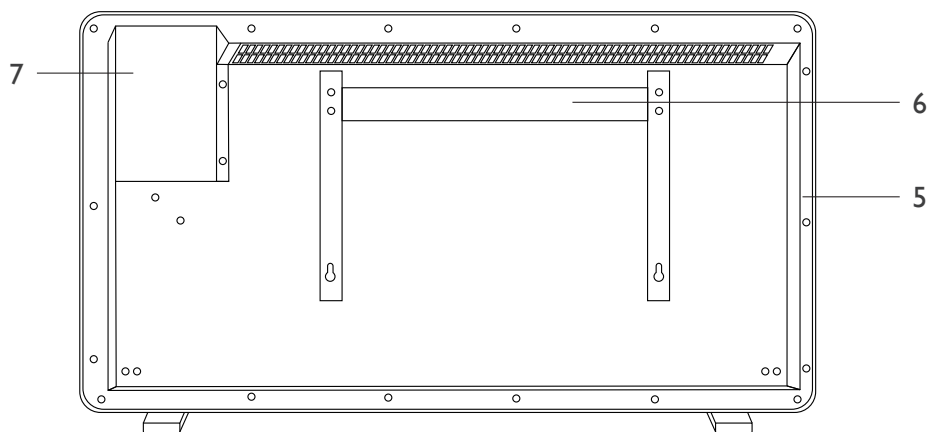
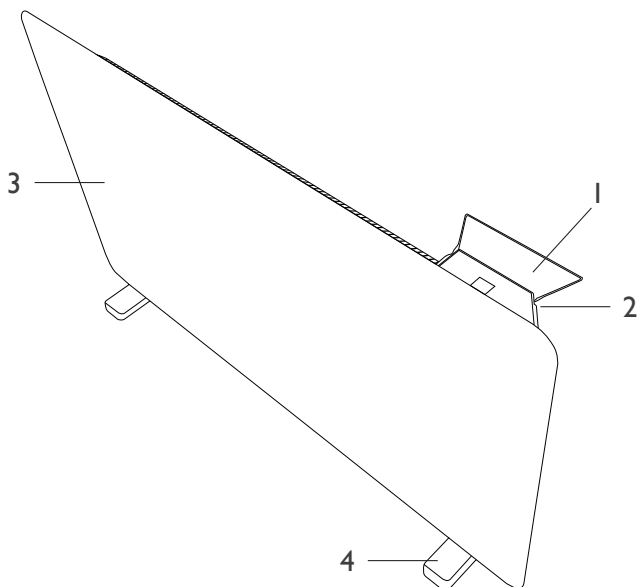
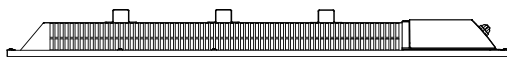

Control Panel and Digital Display

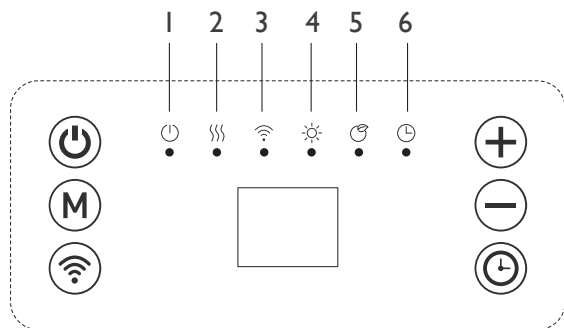

	Standby
	Mode selection
	WiFi
	Increase function
	Decrease function
	Timer

1. Standby: on/off
2. Heating status
3. Wifi
4. Comfort mode
5. ECO mode
6. Timer

ASSEMBLY INSTRUCTIONS

Before assembly: Take the heater out of the box and remove all packaging material. Check the installation parts are not damaged and nothing is missing.

- In order to use the heater, it must be either wall mounted or assembled onto the feet.

Feet Assembly

Turn the appliance upside down on a flat, dry and clean surface. Attach the two feet onto the bottom of the appliance. Ensure the feet are aligned so that the angle matches the angle of the heater and therefore the feet will lie flat on the floor (see fig. 1). Then fix in place with the small screw provided.

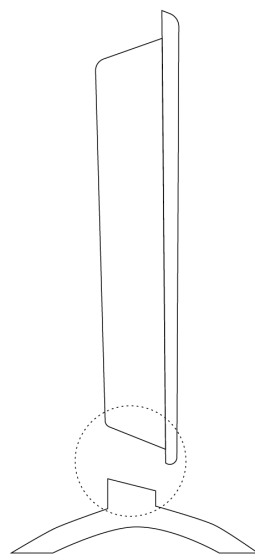
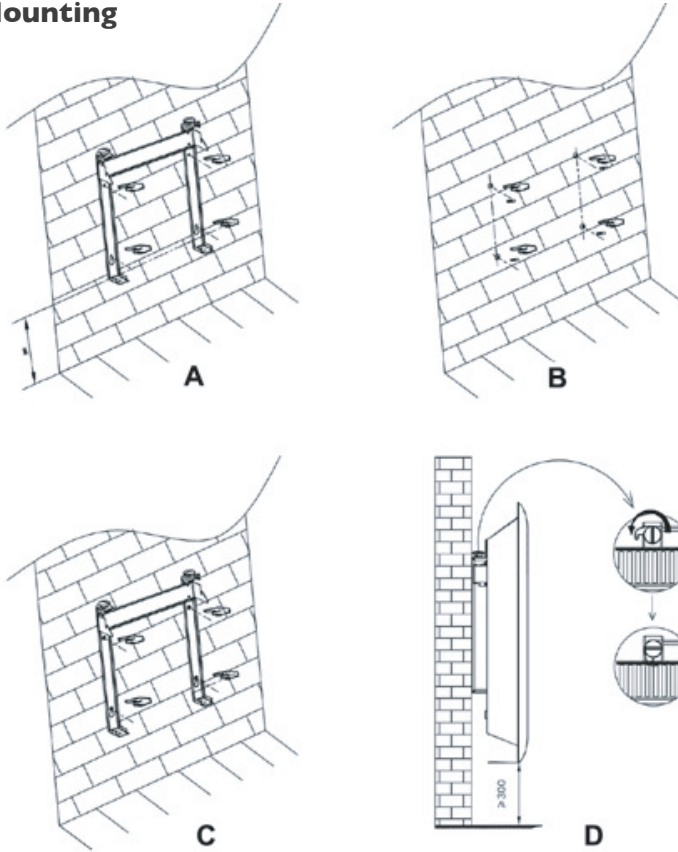

Fig. 1

Wall Mounting



Note: The wall mounting bracket is attached to the back of the appliance via two large plastic screws. These need to be released and the bracket removed before the appliance can be mounted to the wall.

1. Remove bracket from the back of the appliance
2. Secure the wall mounting bracket to the desired location on the wall via the four holes on the bracket (fig A) using the four long screws and wall plugs provided. We suggest using a pen or pencil to position the holes to ensure parallel. Drill holes on the wall with ϕ 8mm drill bit and insert the plastic wall plug (fig B)

Warning! When drilling holes, always check to ensure there is no wiring, pipework, etc. in the area to be drilled

3. Fasten the hanging rack on the wall with the screws, do make sure the hanging rack is in correct direction and position (fig C)
Note: The panel heater should not be placed near inflammable objects such as soft furnishings (e.g. curtains, furniture.) The panel heater should be placed at least 20cm away from any nearby wall sockets and floor
4. Once the bracket is secured to the wall, the panel heater can be attached to the bracket. Gently insert the heater body from the bottom to the hanging rack first and then push the heater body to be hooked on the whole hanging rack (fig D)

Location of the Appliance

- The appliance should be positioned where you most need the warmth.
- Do not locate the appliance under a fixed power point
- Always ensure that the appliance is placed at least 30cm away from furniture, curtains, walls etc
- Do not locate the appliance on a deep pile carpet. This could cause the appliance to be unstable and tip over

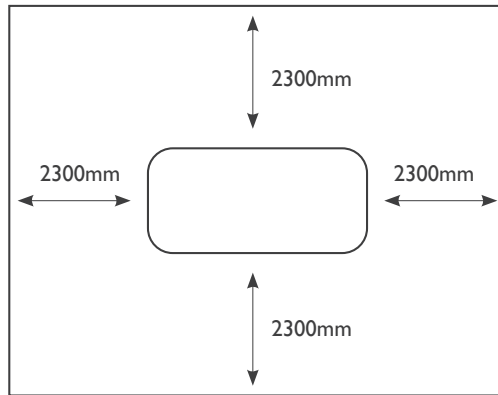



Plugging in the Appliance



Before plugging the appliance into the mains, ensure that your supply voltage is the same as what is shown on the rating plate of the appliance. Avoid contact between the heater and clothes, household linen, furniture, inflammable material and power socket

- Pay attention to the position of the convector with regard to other objects
- Do not place the appliance under a power socket









OPERATING INSTRUCTIONS

- Plug the appliance into socket, and press down on/off switch, located on the side of the heater. The heater will make a beep sound. The indicator light  turns on
- Press  to turn on the heater
- To stop the heater working, press  to turn off the heater
- Unplug the product when it's not in use

Clock and day of week setting:

- Press down  3 secs to enter clock and day of week setting
- The screen display “d”, press  and  to select the day from 1-7

1	Monday	5	Friday
2	Tuesday	6	Saturday
3	Wednesday	7	Sunday
4	Thursday		





- Press  to confirm day setting and enter the clock hour setting, with the screen display: 
- Press  and  to set the current hour
- Press  to confirm hour setting and enter the minute setting, with the screen display: 
- Press  and  to set the current minute
- Press  to confirm all settings

NOTE: The clock and calendar will be reset to factory default if without power supply.

Heating mode:

- Press  to enter mode selection. By pressing , heating mode runs in a continuous cycle as below:



- **Fr** Anti-frost mode: The target temperature is 7°C. The temperature can't be adjusted
- **☀️** Comfort mode: Press  and  to set the temperature from 5-35°C
- **🕒** ECO mode: Press  and  to set the temperature from 1-31°C

NOTE: Under ECO mode, it has a lower max target temp setting to avoid heating excessively to save energy.

- P1/P2/P3: Pre-set heating program

NOTE: For these programs you will need to set day and clock setting in advance

P1: (Monday-Sunday) **Fixed program and cannot be altered**



P2:(Monday-Friday) **Fixed program and cannot be altered**



P2:(Saturday-Sunday) **Fixed program and cannot be altered**



P3:(Monday-Friday) Adjustable program



P3:(Saturday-Sunday) Adjustable program



P3 adjusting the program setting

1. When under P3 mode, press (M) over 3 secs to enter day setting
2. The screen displays d1, press (+) and (-) to set from d1-d7 (d1 being Monday, d7 being Sunday, see chart on pg 11). Press (M) to confirm then enter hour setting
3. The screen displays 00, press (+) and (-) to set the hour (clock is 2400 so select 00-23)

NOTE: you cannot choose minutes only hours

Press (M) to choose heating mode for every hour (Comfort mode ☀ or ECO mode ☾ or no 2 lights for Anti-frost mode)

Repeat the operation until you have completed the schedule of every hour and every day.

NOTE: After setting heating mode for hour 23, press (+) to come back to day setting.

NOTE: When screen displays d 1 , press (+) finish all setting with display of P3

Timer off function

- Press (⊕) one time, the screen display “0H” and keep flashing. Press (+) and (⊖) to set timer from 0-24 hours. Press (⊕) again to confirm setting. Then the indicator light (⊕) is on. The heater will turn off after set time has passed.

Open window function

- When the product is in status of stand-by, long press (M) when the screen display 00 or 0F , press (+) or (⊖) to set the open window function on or off.
- When the heater is under working, the temperature of environment decrease 2 degrees within 2 minutes, the open window function will be activated, the heater will stop working. The screen will display like below:



- Press (M) to get back working.

SETTING UP WI-FI FUNCTION

1. Setting up the igenix app

- Download the igenix app from the Apple store (for iOS devices) or from Google Play (for Android devices) and install the app on your device.
- Register your new igenix account and sign in to the app.

NOTE: This product will only connect to 2.4GHz bandwidth. While most modern routers are dual bandwidth (both 5GHz and 2.4GHz) and will automatically select the correct one for individual WiFi compatible appliances, please try manually adjusting your router to 2.4GHz if struggling to connect.

2. Pair the Glass Panel Heater with your Igenix app

- Plug your IG9521 WIFI/IG9521 BLWIFI into a power socket and leave it in the standby mode.
- Press  more than 3 seconds, the logo  will indicate, open the APP and follow the instruction to connect it. Instruction are also below.

- On the igenix app homepage, click on the '+' icon in the top right hand corner of the screen to add a new device

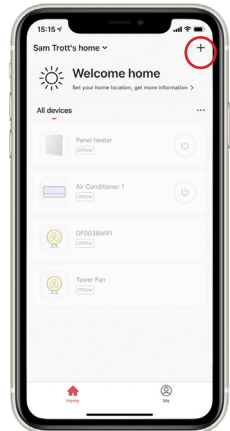

- Once on the 'Add Device' page, click on the 'Add Manually' icon, then press 'Small Home Appliances' and then scroll down until you find the 'Heater' icon.

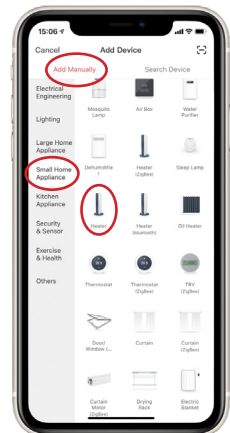

- To complete the 'Add Device' process, you first need to identify whether the Wi-Fi light is flashing rapidly or slowly.
-
- If the light is flashing rapidly, press the **'Confirm indicator rapidly blink'** button at the bottom of the screen to complete the 'Add Device' process.
-
- If the light is **not** flashing rapidly but is flashing slowly, then you need to press the **'AP Mode'** icon in the top right corner of the screen.

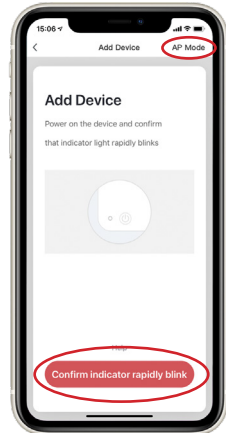

- Once you have clicked on the **'AP Mode'** icon, click on the **'Confirm indicator slowly blink'** button to complete the 'Add Device' process.

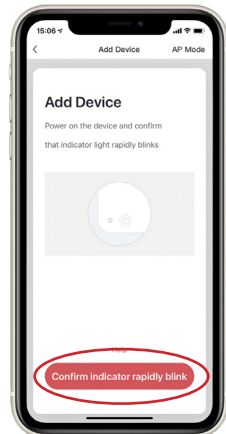

- Once the device configuration is successful, you then have the option to rename the device.

Note: In order to successfully sync with your Amazon Echo, it is advised that you rename your device to an easily recognised word or phrase, such as 'Glass Panel Heater,' as this will have a much greater compatibility with Alexa.

SYNCING DEVICE WITH AMAZON ALEXA

I. Set up Amazon Echo and enable igenix app

- Search the 'Amazon Alexa' app from the Apple store (for iOS devices) or from Google Play (for Android devices) and install the app on your device.

Ia. Set up Echo with Alexa app

Note: You will need to purchase an Amazon Echo device to utilise this functionality. If you already have an echo device that is set up, you can skip this step.

- Plug your Echo device (Echo, Echo Tap or Echo Dot) into a power socket and turn it on.
- Make sure your Echo device is energized.
- Open the Alexa app by tapping the app icon on your mobile device.
- Register for an Amazon account, if you don't have one, or enter your Amazon account and password, then tap 'sign in' (fig. 2).

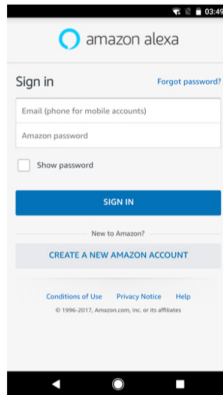

fig.2

- Select the Menu option in the top left corner (fig. 3), select 'Settings' (fig. 4) then tap 'SET UP A NEW DEVICE' (fig. 5).

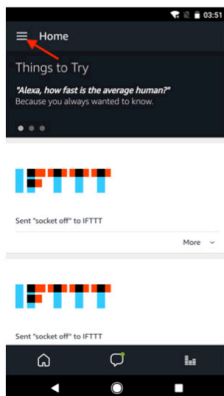

fig.3

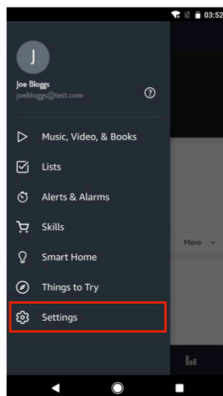

fig.4

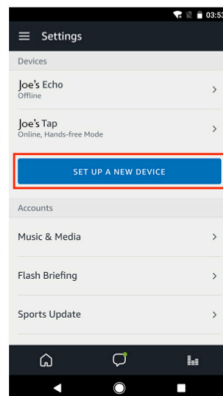

fig.5

- Select your Echo model (fig. 6), choose the appropriate language (fig. 7) and then tap 'CONNECT TO WI-FI' (fig. 8).

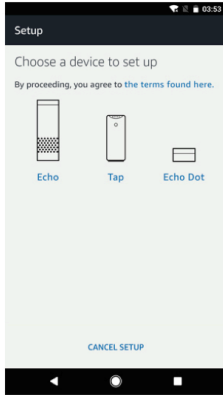

fig.6

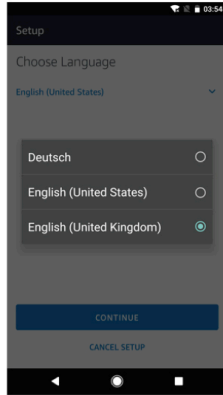

fig.7

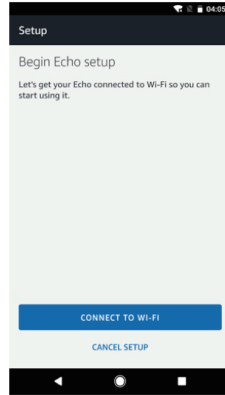

fig.8

- Long press the dot button on the top of your Echo device until the orange light shows up (fig. 9), and then tap 'CONTINUE'. When your device is connected to Echo, tap 'CONTINUE' (fig. 10-11).

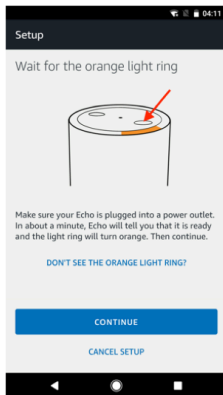

fig.9

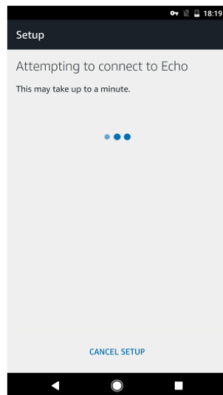

fig.10

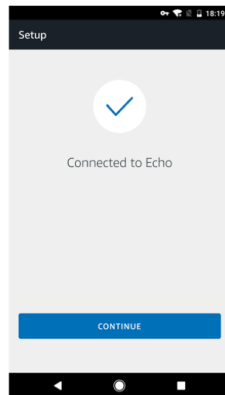

fig.11

- Select a Wi-Fi network to let Echo access the internet (fig. 12). Type in the Wi-Fi password and then tap 'CONNECT' (fig. 13). Echo may take several minutes to connect to the network (fig. 14).

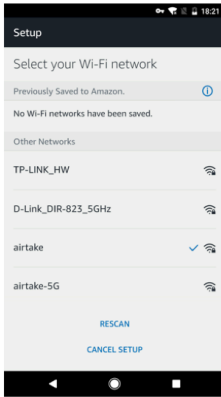

fig.12

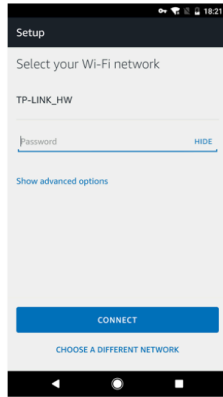

fig.13

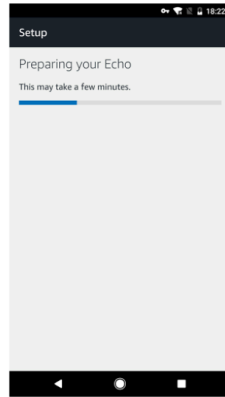

fig.14

- Tap 'CONTINUE' when Echo is connected to the network (fig. 15). After an introduction video, tap 'CONTINUE' to finish the setup (fig. 16).

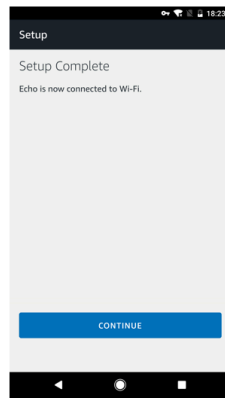

fig.15

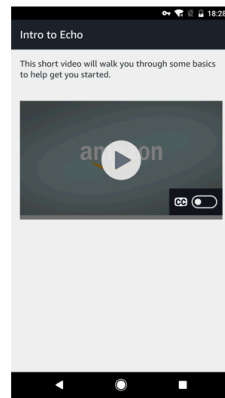

fig.16

Ib. Link igenix app account to Alexa app

- Select the Menu option in the top left corner (fig. 17), and then search ‘Smart Life’ (fig. 18). Select ‘igenix’ and tap ‘ENABLE’ to enable the skill.

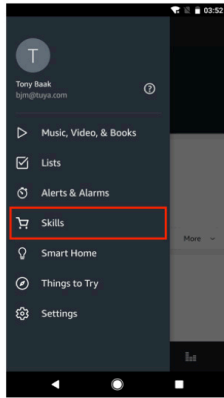

fig.17

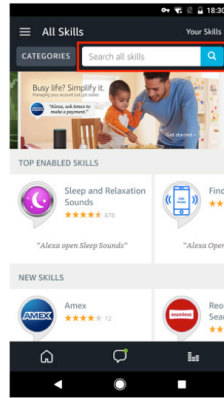

fig.18

- You will be redirected to the account link page.
- Type in your igenix account and password and then tap ‘Link Now’ to link your igenix account (fig. 19).

Note: The country, the account and the password must match the exact content in step 2.

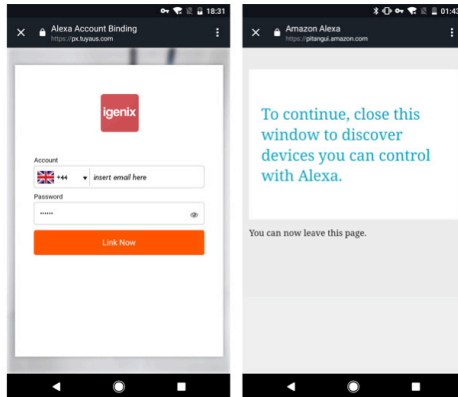

fig.19

2. Control your Glass Panel Heater through Amazon Echo

2a. Discover your IG9521WIFI/IG9521BLWIFI device

- Echo needs to discover your smart devices before it controls them.
- You can say ‘Alexa, discover devices’ to Echo. Then Echo will discover devices that have already been added in the igenix app.
- Alternatively you can select in the ‘Menu’ option ‘Smart Home’ (fig. 20), and then tap ‘DISCOVER’ to discover the smart devices (fig. 21). Discovered devices will be shown in the list (fig. 22).

Note: Every time you change the device’s name in the igenix app, Echo must rediscover before you can control them.

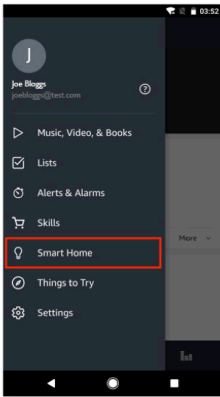

fig.20

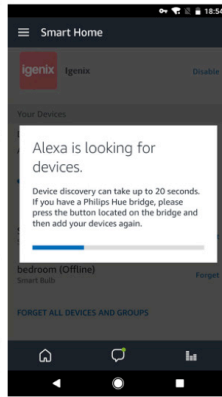

fig.21

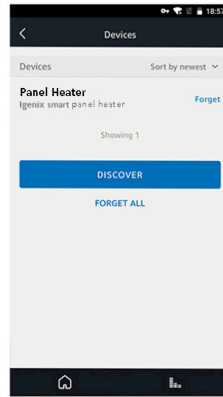

fig.22

2b. Control your Glass Panel Heater by Voice Commands

- Now you can control your IG9521WIFI/IG9521BLWIFI device through Echo. You can use the following commands to control your panel heater:
 - ‘Alexa, turn on panel heater’
 - ‘Alexa, set panel heater to 21°C’
 - ‘Alexa, increase panel heater by 4°C’
 - ‘Alexa, decrease panel heater by 4°C’
 - ‘Alexa, set panel heater to 24°C’
 - ‘Alexa, turn off panel heater’

3. Control your Glass Panel Heater through the Igenix app

The screenshot shows the 'panel heater' control interface in the Igenix app. The main display is red and shows a large '20 °C' temperature. Below this, there are icons for a house (25°C) and a heater. A slider for 'Set Temperature(°C)' is set to 20, with minus and plus buttons. A 'Countdown Timer(hour)' slider is also present. At the bottom, there are icons for different modes (sun, moon, snowflake, window) and a 'Cancel' button. Below that are program buttons 'P1', 'P2', 'P3', and an 'On/Off' power button.

Options for individual heater information

Set temperature

Current room temperature

Current mode

Decrease temperature

Increase temperature

Decrease timer duration

Increase timer duration

Current setting is highlighted

Set programs

On/Off

CLEANING AND MAINTENANCE

- Before attempting any cleaning of the appliance, allow it to cool completely and ensure that the plug is removed from the power supply
- To clean the appliance, use a soft damp cloth without any abrasives or detergents on
- Do not allow water or other liquids to run or enter into the interior of the product, as this could create a fire and/or electrical hazard
- Do not allow dust to build up on any part of the heater - you can use a vacuum cleaner to remove dust from the grill

Storing the Heater

- When the heater is not being used for long periods of time, it should be protected from dust and stored in a clean, dry place. The original packaging box can be saved and used to store the heater away
- If the heater is not going to be used for a long period of time, store the heater in a dry place - it is recommended to store the heater in the original packaging
- Storing the heater in a damp environment could cause the heater to rust and/or affect the electronics in the heater, which is not covered by the warranty

TROUBLESHOOTING GUIDE

If you experience difficulties with the appliance, please check the suggestions below before contacting customer services on 01473 271272:

Problem	Possible Cause	Possible Solution
The appliance does not work.	The appliance is not properly plugged into the wall socket.	Plug the appliance in firmly.
	The appliance is not switched on.	Make sure the appliance is switched on.
	There is no electricity running through the mains wall socket.	Check the fuse or breaker.
The room is too cold.	The power setting is too low.	Switch to a higher power setting.
	The temperature setting is too low.	Switch to a higher temperature setting.
	Draft from windows or door.	Block up any drafts with draft excluders.
The room is too hot.	The power setting is too high.	Switch to a lower power setting.
	The temperature setting is too high.	Switch to a lower temperature setting.

MAINS PLUG FUSE REPLACEMENT

Fuse Replacement (Class I)

This appliance must be earthed. Remove the fuse cover with a small flat head screw driver. Take out the fuse and replace with a new fuse of the same Amp. Replace the fuse cover and push back into place.

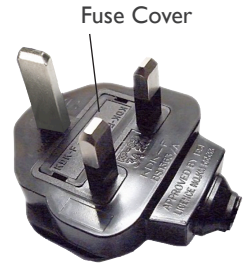

DISPOSAL INFORMATION

The European Directive 2012/19/EU on Waste Electrical and Electronic Equipment (WEEE), requires that old household electrical appliances must not be disposed of in normal unsorted municipal waste.

Old appliances must be collected separately in order to optimise the recovery and recycling of the materials they contain and reduce the impact on human health and the environment.

The crossed out “wheeled bin” symbol on the product reminds you of your obligation, that when you dispose of the appliance it must be separately collected. Consumers should contact their local authority or retailer for information concerning the correct disposal of their old appliance.



Igenix Warranty Terms & Conditions

This product is guaranteed for a period of 12 months as standard from the date of purchase against mechanical and electrical defects. You can extend your warranty for a further 12 months by registering your product.

Upon registration we will cover your product for a period of 24 months from the original purchase date against any mechanical or electrical defects.

To qualify for the warranty, the product must be used for domestic household use only and in accordance with the instructions in the user manual. Any misuse of the product will result in the warranty being void.

The warranty does not cover accidental damage, misuse, neglect, tampering or incorrect adjustment or installation.

The warranty will be rendered invalid if the product is resold, has had its serial number removed (or has an invalid serial number), or if an unauthorised person has carried out any repairs or alterations.

The warranty does not cover accessories or consumable parts that require replacement under normal use. This includes shelving, dials, filters, belts and trays etc.

In the unlikely event of a breakdown please refer to the Troubleshooting guide in your user manual and check all plugs, fuses and the electricity supply.

If you still require assistance please contact our Customer Service department on **01473 271 272** or write to us at the following address:

**Customer Service Department
38 Bluestem Road, Ransomes Europark
Ipswich, IP3 9RR**

Please quote the Product Code which begins 'IG' or 'DF' and the PO Number on the front of the manual, and give details of the exact fault. We will then decide whether to repair or replace the item.

Before we arrange the repair or replacement you will be required to return a copy of your proof of purchase. Please retain your original.

If an item is replaced within the agreed warranty period, the warranty for the replacement item will be calculated from the purchase date of the original.

In the event that the product is inspected and no fault is found or the product is not within the warranty period you will be charged for the repair and any carriage costs.



Thank you for choosing Igenix

As a valued customer we would like to offer you a FREE 2 year warranty to cover your product against any electrical or mechanical defects.

This means that in the unlikely event you develop a fault or problem with your product we will happily repair or replace the item free of charge.

To qualify for the 2 year warranty you must register your product within 30 days of purchase. The full Terms & Conditions of our warranty policy are shown on the opposite page. They are also available on our website. **www.igenix.co.uk**



UK Address: 38 Bluestem Road, Ransomes Europark, Ipswich, IP3 9RR

EU Address: Castle Electrical Factors Ltd., Dundalk, A91 KA9R, IR

Tel. 01473 271 272

Disclaimer: Igenix operate a policy of continual improvement and development.

We therefore reserve the right to change/alter the specification and appearance of our appliances without prior notice.

All diagrams and images shown in this manual are for illustration purposes only.