

# NINJA

# Double Stack XL

2-DRAWER  
AIR FRYER

**9.5L capacity**  
*for large families  
& entertaining*

## SL400UK

### INSTRUCTIONS



ninjakitchen.co.uk

# THANK YOU

for purchasing the Ninja® Double Stack XL 2-Drawer Air Fryer



## REGISTER YOUR PURCHASE

 [ninjakitchen.co.uk/register-guarantee](https://ninjakitchen.co.uk/register-guarantee)

 Scan QR code using mobile device

## RECORD THIS INFORMATION

Model Number: \_\_\_\_\_

Serial Number: \_\_\_\_\_

Date of Purchase: \_\_\_\_\_  
(Keep receipt)

Store of Purchase: \_\_\_\_\_

## TECHNICAL SPECIFICATIONS

Voltage: 220-240V~, 50-60Hz

Watts: 2470W

**TIP:** You can find the model and serial numbers on the QR code label on the back of the unit by the power cord.

# CONTENTS

<b>Product Registration</b> .....	<b>2</b>
<b>Important Safeguards</b> .....	<b>3</b>
<b>Parts</b> .....	<b>5</b>
<b>Getting to Know Your Air Fryer</b> .....	<b>6</b>
Function Buttons .....	6
Operating Buttons .....	6
<b>Before First Use</b> .....	<b>6</b>
<b>Using Your Air Fryer</b> .....	<b>7</b>
Cooking with Double Stack Pro. ....	7
Cooking with DualZone Technology .....	8
Cooking in a single zone .....	9
Air Fry .....	9
Max Crisp .....	10
Bake .....	10
Roast .....	11
Reheat .....	12
Dehydrate .....	12
Ending the Cook Time .....	12
<b>Cleaning &amp; Maintenance</b> .....	<b>13</b>
<b>Helpful Tips</b> .....	<b>13</b>
<b>Troubleshooting Guide</b> .....	<b>14</b>

## PRODUCT REGISTRATION

Please visit [ninjakitchen.co.uk/register-guarantee](https://ninjakitchen.co.uk/register-guarantee) or call 0800 862 0453 to register your new Ninja® product within 28 days of purchase. You will be asked to provide the store name, date of purchase, and model number along with your name and address.

The registration will enable us to contact you in the unlikely event of a product safety notification.

# IMPORTANT SAFEGUARDS

## HOUSEHOLD USE ONLY

Read all instructions before using your Ninja® Double Stack XL 2-Drawer Air Fryer.

When using electrical appliance, basic safety precautions should always be followed, including the following:

## ⚠ WARNINGS

- 1 This appliance can be used by persons with reduced physical, sensory or mental capabilities or lack of experience and knowledge if they have been given supervision or instruction concerning use of the appliance in a safe way and understand the hazards involved.
- 2 Keep the appliance and its cord out of reach of children. **DO NOT** allow the appliance to be used by children. Close supervision is necessary when used near children.
- 3 Children should not play with the appliance.
- 4 **DO NOT** place or store anything on top of product when in use.
- 5 To prevent fire, **DO NOT** place appliance on or near a gas or electric hob, or in a heated oven.
- 6 **NEVER** use electrical socket below counter.
- 7 **NEVER** connect this appliance to an external timer switch or separate remote-control system.
- 8 **DO NOT** use an extension cord. A short power-supply cord is used to reduce the risk of children less than 8 years grabbing the cord or becoming entangled and to reduce the risk of people tripping over a longer cord.
- 9 To protect against electrical shock **DO NOT** immerse cord, plugs, or main unit housing in water or other liquid. Cook only in the drawer provided.
- 10 Regularly inspect the appliance and power cord. **DO NOT** use the appliance if there is damage to the power cord or plug. If the appliance malfunctions or has been damaged in any way, immediately stop use and call Customer Service.
- 11 **ALWAYS** ensure the appliance is properly assembled before use.
- 12 When using this appliance, provide at least 15cm of space above and on all sides for adequate air circulation
- 13 **DO NOT** cover the air intake vent or air outlet while unit is operating. Doing so will prevent even cooking and may damage the unit or cause it to overheat.
- 14 Before placing removable drawer into the main unit, ensure drawer and unit are clean and dry by wiping with a soft cloth.
- 15 This appliance is for household use only. **DO NOT** use this appliance for anything other than its intended use. **DO NOT** use in moving vehicles or boats. **DO NOT** use outdoors. Misuse may cause injury.
- 16 Intended for worktop use only. Ensure the surface is level, clean and dry. **DO NOT** move the appliance when in use.
- 17 **DO NOT** place the appliance near the edge of a worktop during operation.
- 18 **DO NOT** use accessory attachments not recommended or sold by SharkNinja. Do not place accessories in a microwave, toaster oven, convection oven, or conventional oven or on a ceramic cooktop, electric coil, gas burner range or outdoor grill. The use of accessory attachments not recommended by SharkNinja may cause fire, electric shock or injuries.
- 19 **ALWAYS** ensure drawers are properly closed before operating.
- 20 **DO NOT** use the appliance without the removable drawers installed.
- 21 **DO NOT** use this appliance for deep-frying.

- 22 Prevent food contact with heating elements. **DO NOT** overfill when cooking. Overfilling may cause personal injury or property damage or affect the safe use of the appliance.
- 23 Socket voltages can vary, affecting the performance of your product. To prevent possible illness, use a thermometer to check that your food is cooked to the temperatures recommended.
- 24 Should the unit emit black smoke, unplug immediately. Wait for smoking to stop before removing any cooking accessories.
- 25 **DO NOT** touch hot surfaces. Appliance surfaces are hot during and after operation. To prevent burns or personal injury, **ALWAYS** use protective hot pads or insulated oven mitts and use available handles.
- 26 Extreme caution must be used when the appliance contains hot food. Improper use may result in personal injury.
- 27 Spilled food can cause serious burns. Keep appliance and cord away from children. **DO NOT** let cord hang over edges of tables or counters or touch hot surfaces.
- 28 The drawers, racks and crisper plates become extremely hot during the cooking process. Avoid physical contact while removing the drawers, racks and plates from the appliance. **ALWAYS** place drawers, racks and plates on a heat-resistant surface after removing. **DO NOT** touch accessories during or immediately after cooking.
- 29 **DO NOT** place any of the following materials in the unit: paper, cardboard, plastic, roasting bags and the like. They may cause fire.
- 30 Extreme caution should be exercised when using containers constructed of any materials other than metal or glass.
- 31 Cleaning and user maintenance should not be carried out by children.
- 32 To disconnect, turn off any control to OFF, then unplug from socket when not in use and before cleaning. Allow to cool before cleaning, disassembly, putting in or taking off parts and storage.
- 33 **DO NOT** clean with metal scouring pads. Pieces can break off the pad and touch electrical parts, creating the risk of electric shock.
- 34 Please refer to the Cleaning & Maintenance section for regular maintenance of the appliance.



Indicates to read and review instructions to understand operation and use of product.



Indicates the presence of a hazard that can cause personal injury, death or substantial property damage if the warning included with this symbol is ignored.



Take care to avoid contact with hot surface. Always use hand protection to avoid burns.



For indoor and household use only.

## SAVE THESE INSTRUCTIONS

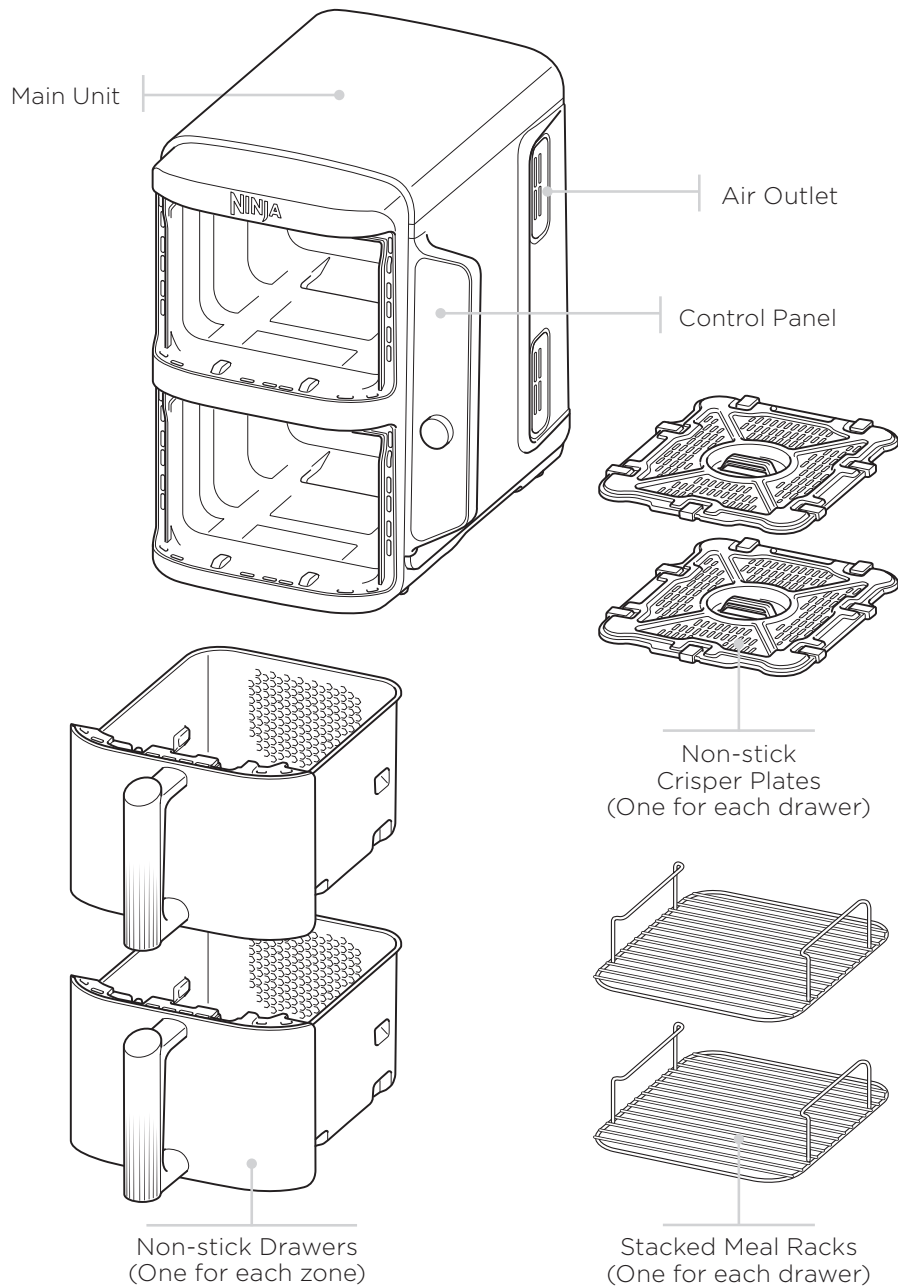

To order additional parts and accessories, visit [ninjakitchen.co.uk](http://ninjakitchen.co.uk) or contact Customer Service at 0800 862 0453.

**FUNCTION BUTTONS**

**AIR FRY:** Use this function to give your food crispiness and crunch with little to no oil.

**MAX CRISP:** Best for cooking smaller quantities of frozen food such as French fries and chicken nuggets, which may need a high temperature.

**BAKE:** Create decadent baked treats and desserts.



**ROAST:** Use the unit as an oven for tender meats and more.

**REHEAT:** Revive leftovers by gently warming them, leaving you with crispy results.

**DEHYDRATE:** Dehydrate meats, fruits and vegetables for healthy snacks.

**Power button:** The  button turns the unit on and also shuts it off and stops all cooking functions.

**OPERATING BUTTONS**

-  Control the output for top zone (Zone 1).
-  Control the output for the bottom zone (Zone 2).

**CRISPER PLATE POSITION:**

Lower position (bottom of drawer): Allows air to surround food for even cooking and crisping. For proper placement, make sure the cutouts are on the left and right sides of the drawer.

Upper position (elevated in drawer): For better browning and grilling results, we suggest using the upper position. Place the crisper plate in the drawer with the cutouts facing the front and back of the drawer.

**BEFORE FIRST USE**

- 1 Remove and discard any packaging material, promotional labels and tape from the unit.
- 2 Remove all accessories from the package and read this manual carefully. Please pay particular attention to operational instructions, warnings and important safeguards to avoid any injury or property damage.
- 3 Wash the drawers, stacked meal racks and crisper plates in hot, soapy water, then rinse and dry thoroughly. The drawers, stacked meal racks and crisper plates are the **ONLY** dishwasher safe parts. However to extend the life of the accessories we recommend hand-washing. **NEVER** clean the main unit in the dishwasher.
- 4 When using this appliance, provide at least 15cm of space on all sides for adequate air circulation.

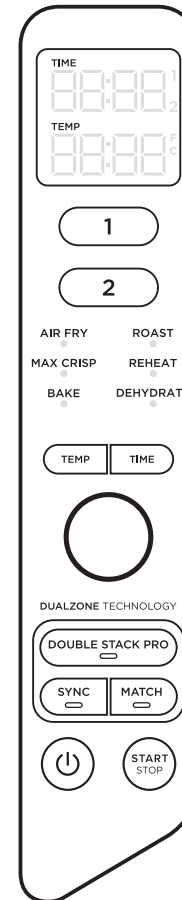

When setting time, the digital display shows HH:MM.

**TEMP button:** Press the **TEMP** button, then turn the dial to adjust the cook temperature before or during cooking.

**TIME button:** Press the **TIME** button, then turn the dial to adjust the cook time in any function before or during the cook cycle.

**DOUBLE STACK PRO:** Cook 4 foods at once in 2 independent air fry drawers for evenly crispy meals and snacks.

**SYNC button:** Automatically syncs the cook times to ensure both zones finish at the same time, even if they have different cook times.

**MATCH button:** Automatically matches zone 2 settings to those of zone 1 to cook a larger amount of the same food or cook different foods using the same function, temperature and time.

**START/STOP button:** Rotate the dial from side to side to select desired function. Start cooking by pressing the **START/STOP** button.

**HOLD MODE:** Hold will appear on the unit while in **SYNC** mode. One zone will be cooking, while the other zone will be holding until the times sync together.

**STANDBY MODE:** After 10 minutes with no interaction with the control panel, the unit will enter standby mode.

# COOKING IN YOUR AIR FRYER

## REFERENCE QUICK START GUIDE FOR RECIPES AND COOKING CHARTS

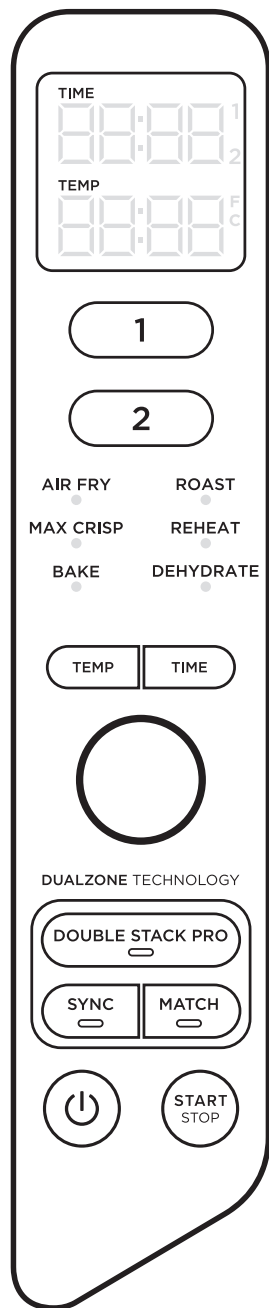

### COOKING WITH DOUBLE STACK PRO

Double Stack Pro allows you to cook 4 foods at once in 2 independent drawers. You can cook in both zones or just in a single zone.

For detailed instructions to use **SYNC** or **MATCH**, see page 8.

When using these functions, Press **DOUBLE STACK PRO** before pressing either **SYNC** or **MATCH**.

When cooking in a single zone, press **DOUBLE STACK PRO** before pressing **START/STOP**.

For detailed instructions on using each function, see pages 9-12.

### ENDING THE COOK TIME IN ONE ZONE (WHILE USING BOTH ZONES)

- 1 Select the zone you would like to stop.
- 2 Press **START/STOP** to end cooking.
- 3 When cooking is complete, the unit will beep and “**COOL**” will appear on the display for 60 seconds.

### PAUSING COOKING

Cooking will automatically pause when a drawer is removed. Re-insert drawer to resume cooking.

### WHEN USING IN SYNC or MATCH MODE

If you open a drawer, the other drawer will automatically pause so that cooking will still finish at the same time. Reinsert drawer to continue cooking in both zones.

### COOKING WITH DUALZONE TECHNOLOGY

DualZone Technology utilises two cooking zones to increase versatility. The Sync feature ensures that, regardless of different cook settings, both zones will finish ready to serve at the same time.

For detailed instructions on using each function, see pages 9-12.

### SYNC

To finish cooking at the same time when foods have different cook times, temperatures, or even functions:

- 1 Place ingredients in the drawers, then insert drawers in unit.
- 2 Select Zone 1. Select the desired cooking function using the dial. Press the **TEMP** button, then turn the dial to set the temperature, and press the **TIME** button, then turn the dial to set the time.
- 3 Select zone 2, then select the desired cooking function using the dial. Press the **TEMP** button, then turn the dial to set the temperature, and use the **TIME** arrows to set the time.

**NOTE:** You can select a different function for zone 2.

- 4 Press **SYNC**, then press **START/STOP** to begin cooking in the zone with the longest time. The other zone will display **Hold**. The unit will beep and activate the second zone when both zones have the same time remaining.

**NOTE:** If you decide the food in one of the zones is done cooking before the cook time is up, you can **PAUSE A ZONE**. Select that zone, then press **START/STOP**. See page 7 for further instructions.

- 5 When cooking is complete, the unit will beep and “**COOL**” will appear on the display for 60 seconds.
- 6 Remove ingredients by tipping them out or using silicone-tipped tongs/utensils.

### MATCH

To cook a larger amount of the same food, or cook different foods using the same function, temperature, and time:

- 1 Place ingredients in the drawers, then insert drawers in unit.
- 2 Select Zone 1. Select the desired cooking function using the dial. Press the **TEMP** button, then turn the dial to set the temperature, and press the **TIME** button, then turn the dial to set the time.
- 3 Press the **MATCH** button to copy the zone 1 settings to zone 2. Then Press **START/STOP** to begin cooking in both zones.
- 4 When cooking is complete, the unit will beep and “**COOL**” will appear on the display for 60 seconds.
- 5 Remove ingredients by tipping them out or using silicone-tipped tongs/utensils.

### Starting both zones at the same time, but ending at different times:

- 1 Select zone 1, then select the desired function using the dial. Press the **TEMP** button, then turn the dial to set the temperature.
- 2 Press the **TIME** button, then turn the dial to set the time.
- 3 Select zone 2 and repeat steps 1 and 2.
- 4 Press **START/STOP** to begin cooking in both zones.

**NOTE:** If you decide the food in one of the zones is done cooking before the cook time is up, you can **PAUSE A ZONE**. Select that zone, then press **START/STOP**. See page 7 for further instructions.

- 5 When cooking is complete, the unit will beep and “**COOL**” will appear on the display for 60 seconds.
- 6 Remove ingredients by tipping them out or using silicone-tipped tongs/utensils.

# COOKING IN YOUR AIR FRYER - CONT.

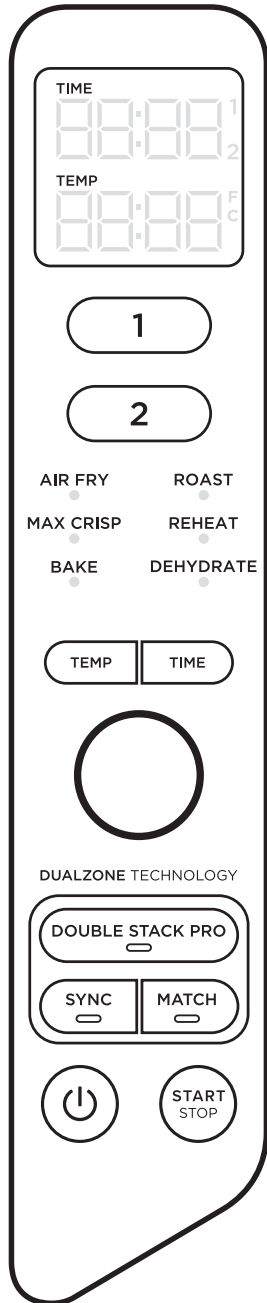

## COOKING IN A SINGLE ZONE

To turn on the unit, plug the power cord into a wall socket, then press the power  button.

### Air Fry

**NOTE:** The temperature is preset to 200°C.

- 1 Install crisper plate in the drawer, then place ingredients in the drawer, and insert drawer in unit.

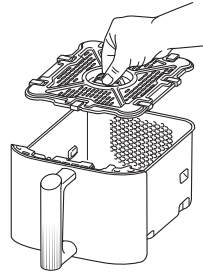

- 2 Select Zone 1 or Zone 2. Select **AIR FRY** using the dial.
- 3 Press **TEMP** and use the dial to set the desired temperature.
- 4 Press **TIME** and use the dial to set the time in 1-minute increments up to 1 hour. Press **START/STOP** to begin cooking.

**NOTE:** During cooking, you can remove the drawer and shake or toss ingredients for evening crisping.

- 5 When cooking is complete, the unit will beep and "**COOL**" will appear on the display for 60 seconds.
- 6 Remove ingredients by tipping them out or using silicone-tipped tongs/utensils.

## Max Crisp

**NOTE:** There is no temperature adjustment available when using the Max Crisp function. The temperature is preset to 240°C.

- 1 Install crisper plate in the drawer, then place ingredients in the drawer, and insert drawer in unit.

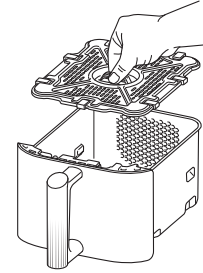

- 2 Select Zone 1 or Zone 2. Select **MAX CRISP** using the dial.
- 3 Press **TIME** and use the dial to set the time in 1-minute increments up to 30 minutes. Press **START/STOP** to begin cooking.
- 4 When cooking is complete, the unit will beep and "**COOL**" will appear on the display for 60 seconds.
- 5 Remove ingredients by tipping them out or using silicone-tipped tongs/utensils.

## Bake

**NOTE:** The temperature is preset to 160°C.

- 1 Install crisper plate in the drawer (optional), then place ingredients in the drawer and insert drawer in unit.

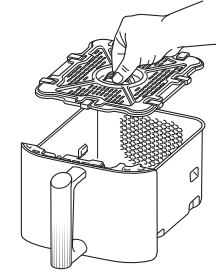

- 2 Select Zone 1 or Zone 2. Select **BAKE** using the dial.

**NOTE:** To convert recipes from a traditional oven, reduce the temperature by 10°C.

- 3 Press **TEMP** and use the dial to set the desired temperature.
- 4 Press **TIME** and use the dial to set the time in 1-minute increments up to 1 hour and in 5-minute increments from 1 to 4 hours. Press **START/STOP** to begin cooking.
- 5 When cooking is complete, the unit will beep and "**COOL**" will appear on the display for 60 seconds.
- 6 Remove ingredients by tipping them out or using silicone-tipped tongs/utensils.

# COOKING IN YOUR AIR FRYER - CONT.

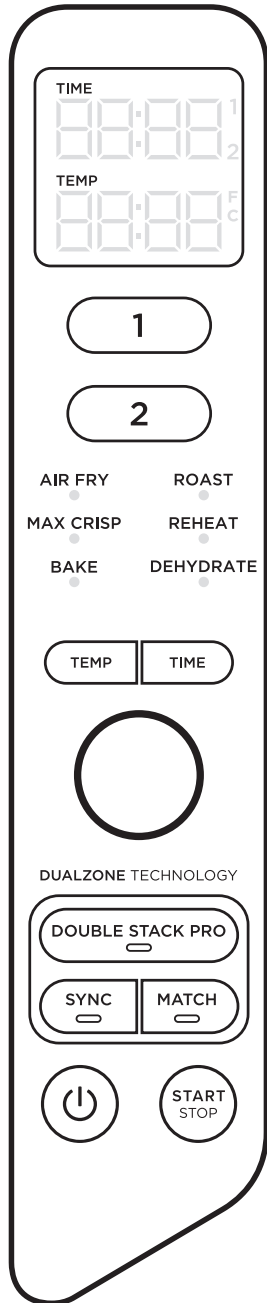

## Roast

**NOTE:** The temperature is preset to 190°C

- 1 Install crisper plate in the drawer (optional), then place ingredients in the drawer and insert drawer in unit.

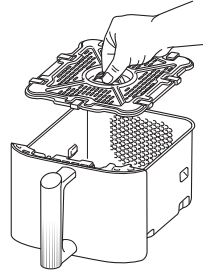

- 2 Select Zone 1 or Zone 2. Select **ROAST** using the dial.
- 3 Press **TEMP** and use the dial to set the desired temperature.
- 4 Press **TIME** and use the dial to set the time in 1-minute increments up to 1 hour and in 5-minute increments from 1 to 4 hours. Press **START/STOP** to begin cooking.
- 5 When cooking is complete, the unit will beep and “**COOL**” will appear on the display for 60 seconds.
- 6 Remove ingredients by tipping them out or using silicone-tipped tongs/utensils.

## Reheat

**NOTE:** The temperature is preset to 170°C

- 1 Install crisper plate in the drawer (optional), then place ingredients in the drawer, and insert drawer in unit.

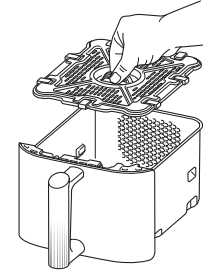

- 2 Select Zone 1 or Zone 2. Select **REHEAT** using the dial.
- 3 Press **TEMP** and use the dial to set the desired temperature.
- 4 Press **TIME** and use the dial to set the time in 1-minute increments up to 1 hour. Press **START/STOP** to begin reheating.
- 5 When cooking is complete, the unit will beep and “**COOL**” will appear on the display for 60 seconds.
- 6 Remove ingredients by tipping them out or using silicone-tipped tongs/utensils.

## Dehydrate

**NOTE:** The temperature is preset to 60°C

- 1 Place a single layer of ingredients in the drawer. Then install the crisper plate in the drawer on top of the ingredients and place another layer of ingredients on the crisper plate.
- 2 Select Zone 1 or Zone 2. Select **DEHYDRATE** using the dial. The default temperature will appear on the display. Press **TEMP** and use the dial to set the desired temperature.
- 3 Press **TIME** and use the dial to set the time in 15-minute increments from 1 to 12 hours. Press **START/STOP** to begin dehydrating.
- 4 When cooking is complete, the unit will beep and “**COOL**” will appear on the display for 60 seconds.
- 5 Remove ingredients by tipping them out or using silicone-tipped tongs/utensils.

**NOTE:** If during cooking when using **SYNC** a drawer is removed for longer than 2 minutes, then the program will be cancelled. You will need to re-program each zone to resume cooking.

## CLEANING & MAINTENANCE

The unit should be cleaned thoroughly after every use. Unplug the unit from the plug socket and wait until the unit is fully cooled before cleaning.

Part/Accessory	Cleaning Method	Dishwasher Safe?
Main Unit	To clean the main unit and the control panel, wipe them clean with a damp cloth <b>NOTE: NEVER</b> immerse the main unit in water or any other liquid. <b>NEVER</b> clean the main unit or drawer in a dishwasher.	No
Drawers, Crisper Plates & Stacked Meal Racks	These can be washed in the dishwasher or by hand. If hand washed air-dry or towel-dry all parts after use. To extend the life of the accessories we recommend hand-washing them.	Yes

If food residue is stuck on the drawers, crisper plates & stacked meal racks place them in a sink filled with warm, soapy water and allow to soak.

## HELPFUL TIPS

- For best results, when using Double Stack Pro always place vegetables/starch in the bottom half of the drawers on the crisper plate and proteins in the upper half using the stacked meal racks.
- For consistent browning, make sure ingredients are arranged in an even layer with no overlapping. If ingredients are overlapping, make sure to shake them at regular intervals through the set cook time.
- Cook temperature and time can be adjusted at any time during cooking. Simply select the zone you want to adjust, Press **TEMP** and use the dial to set the desired temperature or press **TIME** and use the dial to set the time.
- To convert recipes from your conventional oven, reduce the temperature by 10°C. Check food frequently to avoid overcooking.
- Occasionally, the fan from the air fryer will blow lightweight foods around. To alleviate this, secure foods (like the top slice of bread on a sandwich) with cocktail sticks.
- The crisper plates & stacked meal racks elevate ingredients in the drawers so air can circulate under and around ingredients for even, crisp results.
- After selecting a cooking function, you can press **STOP/START** to begin cooking immediately. The unit will run at the default temperature and time.
- For best results with fresh vegetables and potatoes, use at least 1 tablespoon of oil. Add more oil as desired to achieve the preferred level of crispiness.
- For best results, check progress throughout cooking and remove food when desired level of brownness has been achieved. We recommend using an instant-read thermometer to monitor the internal temperature of meat & fish.
- For best results, remove food immediately after the cook time is complete to avoid overcooking.
- For best results with Double Stack Meals, it is not recommended to mix fresh and frozen ingredients within the same drawer. For the best output, cook frozen food loads within 1 drawer.

## TROUBLESHOOTING GUIDE

- How do I adjust the temperature or time while using a single zone?**  
Select the active zone, then press **TEMP** and use the dial to adjust the temperature or press **TIME** and use the dial to adjust the time.
- How do I adjust the temperature or time while using dual zones?**  
Select the desired zone, press **TEMP** and use the dial to adjust the temperature or press **TIME** and use the dial to adjust the time.
- Does the unit need to pre-heat?**  
The unit does not need to be pre-heated.
- Can I cook different foods in each zone and not worry about cross contamination?**  
Yes, both zones are self-contained with separate heating elements and fans.
- How do I pause the countdown?**  
The countdown timer will pause automatically when you remove the drawers from the unit. Reinsert drawer within 15 minutes to resume cooking or the zone with the drawer open will be cancelled.
- How do I pause one zone when using both zones?**  
To pause one zone, first press the zone button then press **STOP/START**. To pause both zones simply press **STOP/START**.
- Is the drawer safe to put on my worktop?**  
The drawer will heat up during cooking. Use caution when handling, and place on heat resistant surfaces only.
- When should I use the crisper plate?**  
Use the crisper plate when you want food to come out crispy. The plate elevates the food in the drawer so that air can flow under and around it to cook ingredients evenly.
- When should I use the stacked meal racks?**  
Use the stacked meal racks when you want to cook two layers of food in one drawer. Place vegetables/starch in the bottom half of the drawer and protein in the upper half of the drawer. It is not recommended to mix fresh and frozen ingredients within the same drawer. For the best output, cook frozen food loads within 1 drawer.
- Why didn't my food cook fully?**  
Make sure the drawer is fully inserted during cooking. For consistent browning, make sure ingredients are arranged in an even layer on the bottom of the drawer with no overlapping. Shake drawer to toss ingredients for even crispiness. Cook temperature and time can be adjusted at any time during cooking. Simply select the desired zone, press **TEMP** and use the dial to adjust the temperature or press **TIME** and use the dial to adjust the time.
- Why is my food burned?**  
For best results, check progress throughout cooking and remove food when desired level of brownness has been achieved. Remove food immediately after the cook time is complete to avoid overcooking.
- Why do some ingredients blow around when air frying?**  
Occasionally, the fan from the air fryer will blow lightweight foods around. Use wooden cocktail sticks to secure loose lightweight food, like the top slice of bread on a sandwich.
- Can I air fry wet, battered ingredients?**  
Yes, but use the proper breading technique. It is important to coat foods first with flour, then with egg, and then with breadcrumbs. Press breadcrumbs firmly onto the battered ingredients, so crumbs won't be blown off by the fan.
- Why is the unit beeping?**  
Either the food is finished cooking or it indicates that the other zone has started cooking.
- Why did the display screen go black?**  
The unit is in standby mode. Press the power **Ⓢ** button to turn it back on.
- Why is there an "E" message on the display screen?**  
The unit is not functioning properly. Please contact Customer Service at 0800 862 0453.



## MANUFACTURER'S GUARANTEE

### The Ninja Guarantee

When a consumer buys a product in the UK, they get the benefit of legal rights relating to the quality of the product (your "legal rights"). You can enforce your legal rights against your retailer, including Ninja if you bought your Ninja kitchen appliance from [ninjakitchen.co.uk](http://ninjakitchen.co.uk). However, at Ninja we are so confident about the quality of our products that we give the owner an additional, free parts and labour manufacturer's guarantee of up to 2 years.

The guarantee it comes with is an important consideration - and reflects how much confidence the manufacturer has in its product and manufacturing quality.

The manufacturer's guarantee does not affect your legal rights.

### How long are new Ninja machines guaranteed for?

Our manufacturer's guarantee lasts for one year from the date of purchase as standard, or for two years if you register your purchase with us within 28 days.

### How do I register my Ninja guarantee?

If you have purchased your Ninja kitchen appliance directly from [ninjakitchen.co.uk](http://ninjakitchen.co.uk) your guarantee is registered automatically. If you bought it from anywhere else in the UK, you can register your guarantee online within 28 days of purchase.

- To register online, please visit [www.ninjakitchen.co.uk/register-guarantee](http://www.ninjakitchen.co.uk/register-guarantee) or scan the QR code in your instruction booklet.

- Keep a note of the date you purchased the machine.

### IMPORTANT:

- **Keep your receipt** if you bought your Ninja kitchen appliance from anywhere except [ninjakitchen.co.uk](http://ninjakitchen.co.uk). You will need it to claim under your guarantee.

- The free Ninja guarantee only applies in the UK.

### What are the benefits of registering my free Ninja guarantee?

When you register your guarantee, you will get an extra year of cover. We'll also have your details to hand if we ever need to get in touch. If you further agree to receive communications from us, you can also receive tips and advice on how to get the best out of your Ninja kitchen appliance and hear the latest news about new Ninja technology and launches.

### What is covered by the free Ninja guarantee?

Repair or replacement (at Ninja's discretion) of your Ninja machine, including all parts and labour.

### What is not covered by the free Ninja guarantee?

- Normal wear and tear.
- Accidental damage or faults caused by negligent use or care, misuse, neglect, careless operation or handling of the Ninja kitchen appliance which is not in accordance with the Ninja Operating Manual supplied with your machine.
- Damage caused by use of the Ninja kitchen appliance for anything other than normal domestic household purposes.
- Damage caused by use of parts not assembled or installed in accordance with the operating instructions.
- Damage caused by use of parts and accessories which are not Ninja Genuine Components
- Faulty installation (except where installed by Ninja).
- Repairs or alterations carried out by parties other than Ninja or its agents.

### How can I claim under the free Ninja guarantee?

Contact our customer service helpline on 0800 862 0453. For service hours please visit our website under 'Contact Us'. It's free to call, and you'll be put straight through to a Ninja representative. You'll also find online support at <https://support.ninjakitchen.co.uk/>. The Ninja representative will go through some **troubleshooting with you, and if we conclude that the item has failed, we will send you a replacement part or a returns label to send the defective item back to us free of charge. When you have delivered the defective product to us, we will send you a replacement.**

**Please remember that the item will need to be boxed when you return it to us. It can be any suitable box, it does not have to be the original packaging.**

### Where can I buy genuine Ninja spares and accessories?

Ninja spares and accessories are developed by the same engineers who developed your Ninja kitchen appliance. You'll find a full range of Ninja spares, replacement parts and accessories for all Ninja machines at [www.ninjakitchen.co.uk](http://www.ninjakitchen.co.uk). Please remember that damage caused by the use of non-Ninja spares may not be covered under your guarantee.



VISIT US ONLINE AT:

ninjakitchen.co.uk

Or follow us on any of our social media pages:



**NOTE:** Save these instructions. Keep for future reference.



This marking indicates this product should not be disposed of with other household waste. To prevent possible harm to the environment or human health from uncontrolled waste disposal, recycle it responsibly to promote the sustainable reuse of material sources. To return your used device, please use the return and collection systems or contact the retailer where this product was purchased. They can take this product for environmentally safe recycling.

**SharkNinja Europe Ltd,  
1st/2nd Floor Building 3150,  
Thorpe Park, Century Way,  
Leeds, England, LS15 8ZB  
0800 862 0453  
ninjakitchen.co.uk**

**SharkNinja Germany GmbH,  
Rotfeder-Ring 9,  
60327 Frankfurt am Main,  
Germany**

Illustrations may differ from actual product. We are constantly striving to improve our products, therefore the specifications contained herein are subject to change without notice.

FOODI and NINJA are registered trademarks in the United Kingdom of SharkNinja Operating LLC.

© 2024 SharkNinja Operating LLC  
SL400UK\_Series\_IB\_MP\_240410\_Mv1

