

KM 3054-1

Gas hob

with electronic functions for maximum safety and user convenience.

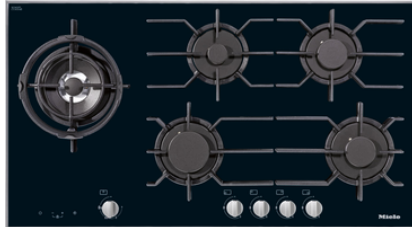

- Optimal - single-handed operation via rotary dials and QuickStart
- Elegant design - 942mm wide gas on glass hob
- Particularly versatile - 5 burners incl. 1 dual wok
- Extremely safe - GasStop&Restart function
- Easy cleaning - dishwasher-safe ComfortClean pot rests

EAN: 4002516120223 / material number: 10939870

Heating type	
Heating type	Gas
Construction type	
Independent of cooker	•
Design	
Elegant glass ceramic surface	•
Cast iron pot rests (matt black enamelled)	•
Cooking zone details	
Number of cooking zones	5
Cooking zone	
Position	front left
Type	High-speed burner
Max. rating in W	2700
Position	rear left
Type	Economy burner
Max. rating in W	1000
Position	Centred
Type	Dual wok burner
Max. rating in W	4700
Position	rear right
Type	Standard burner
Max. rating in W	1700
Position	front right
Type	Standard burner
Max. rating in W	1700
User convenience	
Operation via knobs	•
Electronic ignition with single-hand operation	•
QuickStart	•
Cleaning convenience	
Easy to clean ceramic glass	•
Dishwasher-proof pot rests	•
Safety	
Heat indicator	•
Operational indicator	•
GasStop & ReStart	•
Technical data	
Dimensions in mm (width)	942
Dimensions in mm (height)	53
Dimensions in mm (depth)	526
Cutout dimensions in mm (width) with surface-mounted installation	780
Cutout dimensions in mm (depth) with surface-mounted installation	500
Weight in kg	22
Voltage in V	220-240
Connection cable length in m	1.4
Standard accessories	
Mains cable	•
Wok ring	•
Small trivet	•

more information:
<http://www.miele.co.uk/domestic>

For further information please see next page...

KM 3054-1

Gas hob
with electronic functions for maximum safety and user convenience.

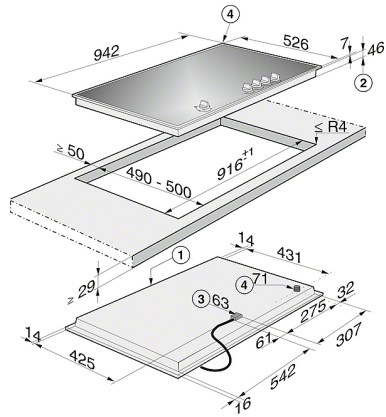
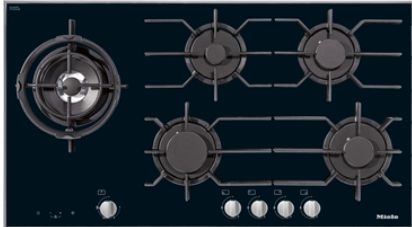

KM 3054 G (installation drawing)

1. Front
2. Casing depth
3. Mains connection box with mains connection cable L = 2000 mm
4. Gas connection R 1/2" - ISO 7-1 (DIN EN 10226)