

W543BX0GB  
 AUTOMATIC WASHING MACHINE  
 FULLY INTEGRATABLE



COOKING PASSION SINCE 1877



A+++



The extraordinarily quiet and durable built-in washing machine with an 8 kg load capacity, practical short cycles and optimal water dispensing.

- ✓ Powerful, intelligent, very quiet EcoSilence Drive motor with 10-year-warranty.
- ✓ Washes, rinses, and spins in just 15 minutes.
- ✓ FlexPerfect – the programme that washes extra fast or extra efficiently.
- ✓ Intelligent Water System – controls the amount of water for any load, for top laundry results.
- ✓ Even 20% better than an appliance with top energy efficiency.

Features

Technical Data

Construction type : Built-in  
 Height of removable worktop (mm) : 820  
 Dimensions of the product (mm) : 818 x 596 x 544  
 Net weight (kg) : 72.0  
 Connection rating (W) : 2300  
 Current (A) : 10  
 Voltage (V) : 220-240  
 Frequency (Hz) : 50  
 Approval certificates : CE, VDE  
 Length of electrical supply cord (cm) : 210  
 Washing performance class : A  
 Door hinge : Left  
 Wheels : No  
 EAN code : 4242004212850  
 Capacity cotton (kg) - NEW (2010/30/EC) : 8.0  
 Energy efficiency class (2010/30/EC) : A+++  
 Energy consumption annual (kWh/annum) - NEW (2010/30/EC) : 157  
 Power consumption in off-mode (W) - NEW (2010/30/EC) : 0.12  
 Power consumption in left-on mode - NEW (2010/30/EC) : 0.50  
 Water consumption annual (l/annum) - NEW (2010/30/EC) : 9900  
 Spin drying performance class : B  
 Maximum spin speed (rpm) - NEW (2010/30/EC) : 1355  
 Average washing time cotton 40C (partial load) - NEW (2010/30/EC) : 255  
 Average washing time cotton 60C (full load) (min) - NEW (2010/30/EC) : 270  
 Average washing time cotton 60C (partial load) - NEW (2010/30/EC) : 270  
 Noise level washing (dB(A) re 1 pW) : 41  
 Noise level spinning (dB(A) re 1 pW) : 67  
 Installation type : Full-integrated



# W543BX0GB

## AUTOMATIC WASHING MACHINE

### FULLY INTEGRATABLE

#### Features

##### Performance

- Capacity: 8 kg
- Energy Efficiency Class: A+++ at a range of energy efficiency classes from A+++ to D
- Maximum spin speed: 1400 rpm
- B spin class
- Energy consumption :157 kWh per year, based on 220 standard washing cycles
- Energy consumption: standard 60 °C cotton programme 0.85 kwh full load and 0.74 kwh partial load and 40 °C cotton programme 0.44 kwh partial load
- Water consumption 9900 litres per year, based on 220 standard washing cycles
- Cottons 60 Eco and Cottons 40 Eco are the standard washing programmes to which the information in the label relates. These programmes are suitable to clean normally soiled cotton laundry and are the most efficient programmes in terms of combined energy and water consumption.
- Programme time:60 °C cotton programme 270 min at full load 270 min at partial load and 40 °C cotton programme 255 min partial load
- Noise level washing : 41dB (A) re 1pW: Noise level spinning:67dB (A) re 1 pW
- Noise level spinning:67dB (A) re 1 pW:

##### Programmes/functions

- Special programmes: Extra Rinse, Drain / Spin, Mixed Load, Rapid 15 min / Rapid 30 min, 30°C, Delicates/silk

##### Key features

- FlexPerfect - actively choose between either saving energy or time
- Touch control buttons: Time Delay, start/pause with reload function, EcoPerfect, SpeedPefect, Spin speed reduction
- Continuous automatic load adjustment system

##### Additional features

- Reload Function – lets you add items even after the programme has started.
  - Large display for programme progress indication, spin speed, remaining time, 24 hour end time delay and load recommendation.
  - EcoSilence Drive
  - EcoSilence drive with 10 year warranty
  - Aquastop with guarantee
  - Foam detection system
  - Safeguard monitoring system adjusts load distribution
  - package
  - Divider for Liquid Detergent
  - Buzzer to indicate the end of cycle
  - Large white door with 130° opening and 30 cm porthole
  - Furniture door is reversible
  - Metal door catch
- ##### Technical Information
- adjustable base height: 15 cm
  - adjustable base depth: 6.5 cm
  - Dimensions (H X W X D): 81.8 x 59.6 x 54.4 cm
  - Height adjustment with Cardan drive

W543BX0GB  
 AUTOMATIC WASHING MACHINE  
 FULLY INTEGRATABLE

Dimensioned drawings

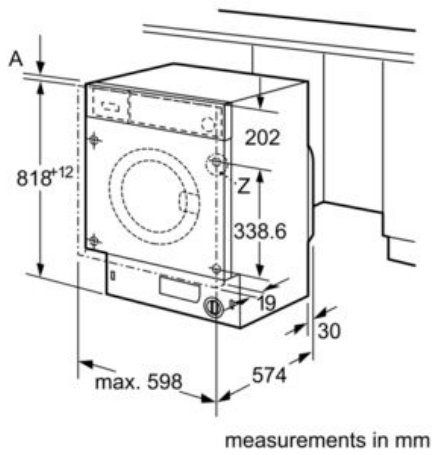

Z detail

